

POLARIS

OFF-ROAD VEHICLES



RANGER



GENERAL



2026

RZR

POLARIS **RANGER**

TOUGH DOESN'T QUIT

When we say we put our machines to the test, we mean it. That's why we were the first in the industry to introduce a STEELDRIVE transmission, increased the towing capacity to 1,587 KG and upped the bed payload to 680 KG. You don't stop at good enough and neither will we, because tough doesn't quit.

PAYLOAD TEST // RANGER XD 1500

POLARIS PROVING GROUNDS



2026 LINEUP

RANGER 500

P. 08



RANGER 500

RANGER SP 570

P. 10



RANGER SP 570 HD

1000 / XP 1000 / XP KINETIC / DIESEL

P. 12



RANGER 1000 PREMIUM



RANGER XP 1000 HD



RANGER DIESEL HD



RANGER XP 1000 NORTHSTAR PREMIUM



2024 RANGER XP KINETIC PREMIUM



2024 RANGER XP KINETIC ULTIMATE



RANGER CREW XP 1000 PREMIUM



RANGER CREW XP 1000 NORTHSTAR PREMIUM

RANGER XD 1500

P. 18



RANGER XD 1500 NORTHSTAR ULTIMATE



RANGER CREW XD 1500 NORTHSTAR ULTIMATE

GENERAL

P. 36



GENERAL XP 1000 SPORT

RZR

P. 46



RZR TRAIL S ULTIMATE



RZR XP SPORT



RZR PRO XP ULTIMATE



RZR PRO R ULTIMATE



RZR PRO R4 ULTIMATE

YOUTH

P. 66



OUTLAW 110



RZR 200

RANGER

HARDEST WORKING. SMOOTHEST RIDING.



BACKED BY A
2 YEAR
LIMITED
WARRANTY*

Make the most of your workday with RANGER, our most capable UTV. Get more done with the ultimate blend of capability, comfort and durability, plus have more fun on the trail when the work's complete.



CAPABILITY

WORK SMARTER, NOT HARDER | Get more done with on-demand all-wheel drive that provides instant traction and powerful hauling and towing for your toughest jobs.



COMFORT

KEEP THE OUTDOORS OUTSIDE | Whatever you do, enjoy it in any weather with enclosed cab options, seating for up to six and accessories designed for rain or shine.



DURABILITY

TACKLE THE TOUGH STUFF | RANGER is built to be durable enough for any job, available with full underbody skid plate, massive front bumper, plus the assurance of a 2-year limited warranty.*

*Terms and conditions apply. See dealer for details.



RANGER

MID-SIZE MODELS

RIGHT TOOL.
RIGHT PRICE.

RANGER 500

MAKE WORK PART OF THE REWARD. With work-ready features like a dump box, factory-installed winch and more, this vehicle is the smart choice for those looking to take on to-dos without breaking the bank.

MAKES WORK EASIER

DUMP BOX

Make fewer trips with the gas-assist dump box. It can haul up to 227 KG.

TOWING

Save time and energy on property tasks. Plus, a standard 2" hitch receiver easily handles heavy loads—enabling you to transport heavy landscaping materials or large brush/branches more efficiently.

WINCH

Clear fallen trees and remove stumps with the pulling power of a factory-installed 1,134 KG winch.

POWER

A 28-HP engine delivers the right amount of power for a smooth, controlled ride, helping you work more efficiently.

EASY TO USE

COMPACT WIDTH

Conveniently store and easily navigate small spaces with a narrow 56" width.

USER-FRIENDLY CONTROLS

Get in and go with simple, intuitive controls. Responsive on-demand all-wheel drive (AWD) automatically engages all four wheels when traction loss is detected to keep you on the move.

INTERIOR STORAGE

Grab what you need, when you need it. Convenient interior storage makes it easy to bring and access essentials—such as your phone, beverages and small tools.

LED HEADLIGHTS

Work when it's convenient thanks to LED headlights, providing better visibility than halogens in low-light conditions.

ROOF

Stay comfortable on long days with a factory-installed roof, offering shade from the sun and protection from brush.

EASY TO OWN

HASSLE-FREE MAINTENANCE

DIY maintenance is easy with convenient access to oil, the air filter and other components.

ON-DEMAND RESOURCES

Have questions about your vehicle? Access our comprehensive online library of owner resources for quick answers—whenever, wherever. Need more help? Easily connect with our product experts via chat or phone.

DEALER NETWORK

Conveniently access vehicle care and service at Authorized Polaris Dealers. Use our Dealer Locator to find one near you.

WARRANTY

Ride with peace of mind thanks to a 2-year warranty.



STANDARD FEATURES

28 HP Prostar Engine

25.4 CM Ground Clearance

25" Tyres

680 KG Towing Capacity

227 KG Box Capacity Roof

LED Headlights

1,134 KG Winch with
Wired Remote

Steel Front Bumper



RANGER MID-SIZE MODELS



GET MORE DONE. HAVE MORE FUN.

RANGER SP 570 HD

DESIGNED FOR WORK AND PLAY. When there's work to be done, RANGER SP 570 makes hauling and towing fast and easy with class-leading capability. When it's time for fun, it offers a smooth ride and handling's a breeze.

FUN TO RIDE

22 CM front / 25 CM rear suspension travel for a smooth, comfortable ride

Class-leading 27cm ground clearance to overcome rocks and ruts on the trail

LED headlights for enhanced lighting during low-light conditions*

GREAT FOR WORK

44 HP ProStar engine for more power
226 KG dump box and 680 KG towing for heavier hauls

AWD for instant traction in tough terrain
VersaTrac Turf Mode to alleviate wear and tear on lawns

Heavy Duty (HD) model includes Active Descent Control (ADC) & Handbrake.

PERFECT FIT

Compact 56" width to navigate tighter trails

Tighter turning radius to maneuver small spaces

Longer service intervals means more uptime for work and play



RANGER SP 570
HD

RANGER FULL-SIZE MODELS

THE EVERYDAY WORKHORSE

RANGER 1000 PREMIUM

UP FOR THE TASK. Make your days count with RANGER 1000. Its powerful engine delivers class-leading hauling and towing to boost efficiency on the job.

CAPABILITY

61 HP ProStar engine delivers smooth, quiet power

Overcome rocky terrain with up to 30 cm of ground clearance

Get more done with 1,134 KG towing capacity and 454 KG box capacity

Factory-installed 2,041 KG winch with synthetic rope, autostop and wireless remote to make light of heavy work

DURABILITY

Gen 2 Transmission reduces shift effort by up to 50% for a consistent feel

Take on rugged terrain with available full-body skid plate, front bumper and CV guards

Built to last with one-piece chassis and beefed up front drive



RANGER 1000
PREMIUM



RANGER XP 1000

POWER THROUGH TASKS AND TRAILS. RANGER XP 1000 delivers sportier performance on the trail and more productivity on the job. Available in 3-seat and 6-seat.

COMFORT

Factory-installed roof for added coverage and redesigned cab nets for easier entry and exit

LED headlights for enhanced illumination in early mornings or late-night tasks

Easy-to-access, in-cab and underseat storage plus a USB charging port for electronics

Contoured seats with back bolsters provide support in rough terrain

CAPABILITY

82 HP ProStar engine to put more power to tasks and trails

Class-leading 454 KG box capacity and 1,134 KG towing capacity to get more done in fewer trips

35.5 CM of ground clearance to overcome tough terrain

3-position throttle control with Performance, Standard and Work drive modes for specific use case scenarios

Factory-installed Polaris HD 2,041 KG winch to pull through the unexpected

Heavy Duty (HD) model includes Active Descent Control (ADC) & Handbrake.

DURABILITY

Gen 2 Transmission reduces shift effort by up to 50% for a consistent feel

Rigid one-piece chassis, redesigned front end with larger front bumper and a full-body skid plate for added strength

29" 8-ply Pro Armor X-Terrain tyres provide enhanced puncture resistance



RANGER XP 1000
HD



RANGER CREW XP 1000
PREMIUM

RANGER FULL-SIZE MODELS

TASK TO TRAIL VERSATILITY

RANGER XP 1000 NORTHSTAR EDITION

POWER THROUGH TASKS AND TRAILS IN ANY WEATHER. The performance of a RANGER XP 1000, with a full cab system and factory-installed heating and air conditioning. Available in 3-seat and 6-seat.

COMFORT

Enclosed cab system offers tight sealing protection from the elements

Heat and air conditioning for all-season comfort

CAPABILITY

82 HP ProStar engine to put more power to tasks and trails

Class-leading 454 KG box capacity and 1,134 KG towing capacity to get more done in fewer trips

36 CM of ground clearance to overcome tough terrain

3-position throttle control with Performance, Standard and Work drive modes for specific use case scenarios

Factory-installed 2,041 KG winch to pull through the unexpected

DURABILITY

Gen 2 Transmission reduces shift effort by up to 50% for a consistent feel

Rigid one-piece chassis, redesigned front end with larger front bumper and a full-body skid plate for added strength

29" 8-ply Pro Armor X-Terrain tyres provide enhanced puncture resistance



RANGER XP 1000
NORTHSTAR
PREMIUM



RANGER CREW
XP 1000
NORTHSTAR
PREMIUM



RANGER DIESEL

BUILT FOR HARD WORK. The RANGER Diesel delivers rugged, reliable performance with its Kubota 3-cylinder diesel engine, high towing and payload capacities, and enhanced durability to power through the toughest jobs every day.

CAPABILITY

898cc, 24.8 HP Kubota Diesel Engine

454 KG box capacity and 1,134 KG towing to get more done in fewer trips

33 CM ground clearance to handle rough terrain with ease

Optimised power for the task at hand with three drive systems: High-performance on-demand true AWD, 2WD and VersaTrac Turf Mode

Heavy Duty (HD) model includes Active Descent Control (ADC) & Handbrake.

DURABILITY

Gen 2 Transmission reduces shift effort by up to 50% for a consistent feel

Rigid one-piece chassis, redesigned front end with larger front bumper and a full-body skid plate for added strength

27" Pro Armor X Terrain Tyres with Variable Tread Pattern for Reduced Cab Noise



RANGER DIESEL
HD



2024 RANGER XP KINETIC

THE POWER TO DO MORE. The RANGER XP Kinetic provides the power to do more with uncompromised capability, unrivaled durability and the refined performance of an all-electric powertrain. Available in 3-seat only.

CAPABILITY

- 110 HP electric motor and 190 Nm torque for effortless hauling and towing
- 567 KG box capacity and 1,134 KG towing to get more done in fewer trips
- 35.5 CM ground clearance to handle rough terrain with ease
- Optimised power for the task at hand with three drive modes: Eco+, Standard and Sport

DURABILITY

- Backed by a 2-year limited warranty plus 3-year warranty for powertrain & 5-year battery coverage for added assurance*
- Enjoy more uptime as maintenance costs are estimated to be 70% less than the average for similar gas-powered vehicles**
- A rigid one-piece chassis, full-body skid plate and large front bumper are ready to face rough terrain

COMFORT

- Clean, quiet operation for easy conversation and stealthy trips to hunting spots
- Convenient interior storage with dual glove boxes and under-seat storage
- 7" Display powered by RIDE COMMAND for easy GPS navigation***



2024 RANGER XP KINETIC PREMIUM



2024 RANGER XP KINETIC ULTIMATE

*Terms and conditions apply. See dealer for details.
 **Manufacturer estimate based on average scheduled maintenance costs over the course of a 5-year timeframe.
 ***Available on 2024 RANGER XP Kinetic Ultimate

RANGER EXTREME DUTY MODELS

A CLASS OF
ITS OWN

RANGER XD 1500 NORTHSTAR EDITION

EXTREME DUTY. EXTREME COMFORT. RANGER XD 1500 NorthStar delivers extreme comfort with the most spacious, premium and refined cab we've ever built. Available in 3-seat and 6-seat.

CAPABILITY

ProStar 1500cc engine delivering 110 HP / 142 Nm torque for industry-leading power

Get more done with an impressive 1,588 KG towing and 680 KG box capacity

30" Kenda® Cross Trail tyres with industry-leading 38 CM of ground clearance for confident riding and handling

Factory-installed Pro Series 2,721 KG winch with Rapid Rope Recovery to get the job done efficiently

DURABILITY

One piece, high-strength, heavy duty steel chassis for added durability

Industry-exclusive STEELDRIVE transmission offers smooth, precise control and added strength

COMFORT

Cab system seals and protects from the elements

Upgraded heating and air conditioning for complete climate control

Heated contoured seats with back bolsters for the long hauls

Available 7" Display powered by RIDE COMMAND for easy GPS navigation

JBL® audio for immersive sound



RANGER XD 1500
NORTHSTAR
ULTIMATE



RANGER XD 1500
NORTHSTAR
ULTIMATE

RANGER

ACCESSORIES



OWNER ESSENTIALS PACKAGE

2891577 Poly Front Fixed Windshield
2891578 Poly Rear Panel
98320 Side View Mirrors

2889187 Convex Weatherproof Rear View Mirror
2889791 Pro Armor 33" Single-Row Combo
LED Light Bar

2884657 Polaris PULSE LED Light Bar
Wiring Harness
2891666 Front Pulse Bar and Harness

COMFORT & CONVENIENCE



NEW
POLY FRONT FIXED WINDSHIELD

- A strong reliable barrier against wind, rain, dust and flying debris—keeping the cab protected and comfortable in any weather
- Made from optical grade, scratch resistant polycarbonate. Delivers clear visibility and rugged protection you can count on through the toughest terrain
- Installs in minutes—just clamp this front windshield to dashboard and hit the trail with confidence. Designed to pair with manual windshield wipers

» 2891577
RANGER 500 '26



NEW
POLY REAR PANEL

- A strong barrier against wind, rain, dust and debris—keeping the cab protected and rear visibility clear in any weather
- Made from optical grade, scratch resistant polycarbonate
- Installs in minutes—just clamp it to rear panel behind the seats and hit the trail

» 2891578
RANGER 500 '26



KOLPIN
OUTDOORS
GLASS WINDSHIELD WITH VENTS

- Scratch-resistant, DOT-approved glass
- No-gap seal
- Dual sliding vents increase in-cab air-flow
- Designed to pair with Manual Wiper Kit (28000), sold separately

» 28135
RANGER 500 '26
NOT COMPATIBLE WITH SIDE MIRRORS (98320)



KOLPIN
OUTDOORS
MANUAL WIPER KIT

- Easy hand operated durable UTV wiper
- Plug & Play with Glass Windshields
- Quick & easy install to poly windshields
- 13" Steel arm with a 12" rubber blade

» 28000
RANGER 500 '26



KOLPIN
OUTDOORS
SIDE VIEW MIRRORS

- 4.9" W x 8.5" H single view lens for wide viewing range
- Easy Installation
- Rugged fold-in and break-away design
- Adjustable spring tension to fold-in
- Included clamps fit 1 5/8" - 2" round tubing and Polaris profile tubes
- Low-profile clamp compatible with most windshields and doors
- Set of two mirrors

» 98320
RANGER 500 '26
NOT COMPATIBLE WITH THE GLASS WINDSHIELD WITH VENTS (28135)



CONVEX WEATHERPROOF REAR VIEW MIRROR

- Convex design for a broader view of traffic
- Durable, weatherproof construction
- Mount the bolts into your choice of pre-designated mounting locations
- Compatible with roof, windshield and other accessories

» 2889187
RANGER 500 '26



SUN VISOR

- Injection molded visors for seamless fit to protection from the sun

» 2890288
RANGER 500 '26

PREMIUM ROOF LINER

- Cut in-cab noise by 60% at idle and by 40% at 32 KM/H
- One-piece liner attaches quickly and securely using push darts
- Adds premium comfort and quieter cab ride

» 2-SEAT (SHOWN) • 2885093
RANGER 500 '26

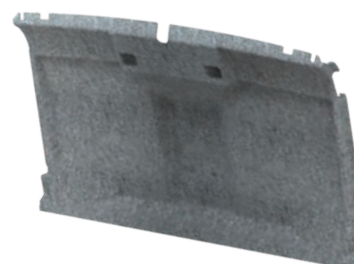



OWNER ESSENTIALS PACKAGE

- 2885077 Sport Roof - Poly
- 2885080 Full Windshield - Glass
- 2879965  Rear Panel - Glass
- 2889243 Side View Mirrors - ROPS-Mounted
- 2889187 Convex Weatherproof Rear View Mirror
- 2890288 Sun Visor
- 2885095 3,500 LB Winch





FARM PACKAGE

- 2889538 Rear Headache Rack - Winch Ready
- 2889187 Convex Weatherproof Rear View Mirror
- 2885095 1,133 KG Winch
- 2889189 Cargo Bed Mat





TRAIL PACKAGE

- 2889199  Storage Box
- 2880551 Rear A-Arm Guards
- 2889790 Pro Armor 31" Dual-Row Combo LED Light Bar
- 2890053 Light Bar Mount
- 2889161 Polaris PULSE Wiring Harness - 1 LED Light Bar







WINTER PACKAGE

- 2889577 Pro Series Plow Mount Quick Release Hook
- 2880260 Pro Series Frame
- 2890335 Plow Blade - 72" Steel
- 2889032 Pro Series Plow Hydraulic Angle System
- 2889162 Plow Controller
- 2889791 Pro Armor 33" Single-Row Combo LED Light Bar
- 2889161 Polaris PULSE Wiring Harness - 1 LED Light Bar







HUNT PACKAGE

- 2889199  Storage Box
- 2889538 Headache Rack
- 2890134 300 LB Rear Cargo Box Winch
- 2885088  Front Hood Storage Rack
- 2884299 RIGID® 32" SR-Series Combo LED Light Bar
- 2890053 Light Bar Mount
- 2889161 Polaris PULSE Wiring Harness - 1 LED Light Bar
- 2884106  Kolpin Stronghold Auto-Latch Boot Mount
- 2882036 Kolpin Stronghold Gun Boot XL





LANDOWNER PACKAGE

- 2889189 Cargo Bed Mat
- 2889199  Storage Box
- 2881533  Tool Rack
- 2889791 Pro Armor 33" Single-Row Combo LED Light Bar
- 2882209 Light Bar Harness



1000 / XP 1000 / XP KINETIC / DIESEL

CUSTOMISE YOUR RANGER



OWNER ESSENTIALS PACKAGE

- 2891680 Full Windshield - Glass*
- 2879013  Rear Panel - Glass
- 2890288 Sun Visor
- 2889243 Side View Mirrors - ROPS-Mounted
- 2889220 Weatherproof Convex Rear View Mirror Kit

NORTHSTAR EDITION ▶



- 2890288 Sun Visor
- 2890440 Auxiliary Lights - Front Bumper
- 2889241 Side View Mirrors - Door Mounted
- 2890232 Upper Front Bumper
- 2882529 Standard Rear Bumper
- 2883230 Polaris PULSE Wiring Harness - 1 LED Light Bar

*Fits XP 1000 only. RANGER 1000 requires Lock & Ride Full Glass Windshield - Clear (2889030).





FARM/RANCH PACKAGE

- 2882752  Bed Extender
- 2890233  Headache Rack
- 2883127 RIGID® D-Series PRO Spot LED Light
- 2884299 RIGID® SR-Series 32" Combo LED Light Bar
- 2883230 Polaris PULSE Wiring Harness - 1 LED Light Bar
- 2879860 Y-Harness
- 2889679 Reverse Light Harness



1000 / XP 1000 / XP KINETIC / DIESEL



TRAIL RIDING PACKAGE

- 2882530 Rock Sliders with Step
- 2889689 Mud Guards
- 2889193  Spare Tyre Carrier

- 2883122 RIGID® SR-Series 10" Flood LED Light
- 2883230 Polaris PULSE Wiring Harness - 1 LED Light Bar
- 2883425 Polaris NorthStar 60 QT Cooler



WINTER PACKAGE

- 2889328 6" Plow Extensions
- 2889308 Pro Series Push Frame
- 2889058 Pro Series Plow Hydraulic Lift System
- 2879317 Pro Series Plow Blade - 72" Poly

SCAN TO SHOP
THIS PACKAGE



- 2889029 Pro Series Plow Hydraulic Angle System
- 2883247 Plow System Power Controller
- 2889329 Back Drag Bar - 72"
- 2889793 Pro Armor 40" Single-Row Combo LED Light Bar
- 2883230 Polaris PULSE Wiring Harness - 1 LED Light Bar





LANDOWNER PACKAGE

- 2889672 Rear LED Work Light
- 2889679 Reverse Light Harness
- 2882177  CargoMax System

- 2889876 Trash Can Hauler
- 2889793 Pro Armor 40" Single-Row Combo LED Light Bar
- 2883230 Polaris PULSE Wiring Harness - 1 LED Light Bar



HUNT PACKAGE

- 2890583 Front Hood Storage Rack
- 2890233  Headache Rack
- 2889705 136 KG Rear Cargo Box Winch

- 2882904 Polaris PULSE Roof 6
- 2883970  Kolpin Stronghold Auto-Latch Double Boot Mount
- 2882036 Kolpin Stronghold Gun Boot XL



RANGER XD 1500

CUSTOMISE YOUR RANGER



OWNER ESSENTIALS PACKAGE

- 2884872 Upper Front Bumper
- 2884876 Rear Bumper
- 2889862 Door-Mounted Side View Mirrors

- 2890571 Sun Visor
- 2889108  Storage Box



RANCH PACKAGE

- 2884872 Upper Front Bumper
- 2884878  Front Hood Storage Rack
- 2889666 Rear Headache Rack - Winch Ready
- 2889847  Modular Cargo System (MCS)

- 2889846  MCS Tool Rack
- 2884299 RIGID® SR-Series 32" Combo LED Light Bar
- 2889930 Cast Light Bar Mount
- 2889738 PULSE Light Bar Harness - Dash Switched



HUNT PACKAGE

- | | | | |
|---------|----------------------------------|---------|--|
| 2884872 | Upper Front Bumper | 2889698 | 1,000 LB Rear Cargo Box Winch |
| 2889800 | Cross Bed Rail | 2889931 | Kolpin Stronghold Gun Mounting Bracket |
| 2884878 | Front Hood Storage Rack | 2884299 | RIGID® SR-Series 32" Combo LED Light Bar |
| 2889666 | Rear Headache Rack - Winch Ready | 2882036 | Kolpin Stronghold Gun Boot XL |



FARM PACKAGE

- | | | | |
|---------|----------------------------------|---------|--|
| 2884878 | Front Hood Storage Rack | 2889109 | Bed Extender |
| 2889108 | Storage Box | 2889791 | Pro Armor 33" Single-Row Combo LED Light Bar |
| 2889666 | Rear Headache Rack - Winch Ready | | |

MAINTENANCE PARTS & FLUIDS

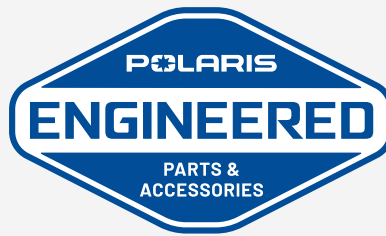

POLARIS ENGINEERED PARTS AND OIL have been validated and tested extensively, specifically for your vehicle. In order to maintain the peak performance of your Polaris vehicle only use official Polaris Engineered parts and oil.



We're taking the passion of our riders, workers and outdoor enthusiasts to the next level with HD Parts. These Heavy Duty parts are engineered for riders who want greater durability and enhanced performance. HD Parts are designed and tested to handle greater wear and tear under all weather conditions.



A DRIVE BELT

- » 1000 • 3211218
- » XP 1000 • 3211186
- » XP 1000 • **HD** • 3212358
- » XP KINETIC • 3212327



B BRAKE PADS

- » FRONT • 2209279
- » FRONT • **HD** • 2208933
- » REAR • 2209280
- » REAR • **HD** • 2208936



C OIL FILTER

- » 2540086
 - » **HD** • 2522498
- XP KINETIC DOES NOT HAVE AN OIL FILTER



D BATTERY

- » 4014132-P
- » **HD** • 4081855



E AIR FILTER

- » 7082265
- 1000/ XP 1000
- » **HD** • 7083113
- 1000/ XP 1000



F SPARK PLUGS

- » 1000 • 3023571
- » XP 1000 • 3022662

MAINTENANCE SCHEDULE*

RANGER 1000 / XP 1000

BREAK-IN MAINTENANCE

FIRST 25 HRS | 500 MI / 800 KM

- ENGINE OIL & OIL FILTER**
CHANGE
- FRONT GEARCASE**
INSPECT FLUID
- BRAKE PADS**
INSPECT
REPLACE AS NEEDED
- BRAKE FLUID**
INSPECT
ADD FLUID AS NEEDED
- TRANSMISSION FLUID**
INSPECT
ADD FLUID AS NEEDED

12 MONTHS

200 HRS | 2,000 MI / 3,200 KM

- ENGINE OIL & OIL FILTER**
CHANGE
- TRANSMISSION FLUID**
CHANGE FLUID
- FRONT GEARCASE**
CHANGE FLUID
- AIR FILTER**
REPLACE
- BRAKE PADS**
INSPECT
REPLACE AS NEEDED
- DRIVE BELT**
INSPECT
REPLACE AS NEEDED
- SPARK PLUGS**
INSPECT
REPLACE AS NEEDED
- BATTERY**
TEST & CLEAN
REPLACE AS NEEDED
- GENERAL LUBRICATION**
ALL FITTINGS, PIVOTS, CABLES, ETC.

24 MONTHS

400 HRS | 4,000 MI / 6,400 KM

- ENGINE OIL & OIL FILTER**
CHANGE
- TRANSMISSION FLUID**
CHANGE FLUID
- AIR FILTER**
REPLACE
- BRAKE FLUID**
CHANGE
- FRONT GEARCASE**
CHANGE FLUID
- BRAKE PADS**
INSPECT
REPLACE AS NEEDED
- DRIVE BELT**
INSPECT
REPLACE AS NEEDED
- SPARK PLUGS**
INSPECT
REPLACE AS NEEDED
- BATTERY**
TEST & CLEAN
REPLACE AS NEEDED
- GENERAL LUBRICATION**
ALL FITTINGS, PIVOTS, CABLES, ETC.



G

ENGINE OIL

- » PS-4 • 1QT • 2876244
 - » PS-4 • 1GAL. • 2876245
 - » PS-4 EXTREME • 1QT • 2889395
 - » PS-4 EXTREME • 1GAL. • 2889396
- NOT COMPATIBLE WITH XP KINETIC



H

ANGLE DRIVE FLUID

- For rear gearcase
- » 1QT • 2889280
- ONLY COMPATIBLE WITH XP KINETIC



I

DEMAND DRIVE FLUID

- For front gearcase
- » 1QT • 2877922
 - » 2.5 GAL. • 2877923



J

AGL

- For transmission
- » 1QT • 2878068
 - » 1GAL. • 2878069
 - » EXTREME • 1QT • 2891028



K

DOT 4 BRAKE FLUID

- » 12 OZ • 2872189



MAINTENANCE MADE EASY



ORV MAINTENANCE KIT

Includes Oil Change Kit, Gearcase Fluids, Air Filter, & Spark Plug

- » 2830556

XP 1000 '18-26



OIL CHANGE KITS

2.5 QT Engine Oil (oil varies by kit), 1 Oil Filter (2540086) & 1 Drain Plug Washer

- » PS-4 • 2879323
- » PS-4 EXTREME • 2890057

NOT COMPATIBLE WITH XP KINETIC



ALL-SEASON GREASE TUBE

- » 3 OZ • 2871322
- » 14 OZ • 2871423

Claims made based off testing and performance of Polaris HD Parts against standard OEM parts made by Polaris and competitor brands under normal use. For more information regarding Polaris HD parts including vehicle compatibility, installation and maintenance, please contact your authorized Polaris ORV dealer.

RANGER XP KINETIC

36 MONTHS

600 HRS | 6,000 MI / 9,700 KM

- ENGINE OIL & OIL FILTER**
CHANGE
- TRANSMISSION FLUID**
CHANGE FLUID
- AIR FILTER**
REPLACE
- BRAKE PADS**
INSPECT
REPLACE AS NEEDED
- FRONT GEARCASE**
CHANGE FLUID

- DRIVE BELT**
INSPECT
REPLACE AS NEEDED
- SPARK PLUGS**
INSPECT
REPLACE AS NEEDED
- BATTERY**
TEST & CLEAN
REPLACE AS NEEDED
- GENERAL LUBRICATION**
ALL FITTINGS, PIVOTS,
CABLES, ETC.

EVERY 1,000 MILES

1,600 KM

- TRANSMISSION FLUID**
CHANGE FLUID
- FRONT GEARCASE**
CHANGE FLUID
- BRAKE PADS**
INSPECT
REPLACE AS NEEDED
- BATTERY**
TEST & CLEAN
REPLACE AS NEEDED
- GENERAL LUBRICATION**
ALL FITTINGS, PIVOTS,
CABLES, ETC.

EVERY 2,000 MILES

3,200 KM

- TRANSMISSION FLUID**
CHANGE
- FRONT GEARCASE**
CHANGE FLUID
- BRAKE FLUID**
CHANGE
- BRAKE PADS**
INSPECT
REPLACE AS NEEDED
- BATTERY**
TEST & CLEAN
REPLACE AS NEEDED
- GENERAL LUBRICATION**
ALL FITTINGS, PIVOTS, CABLES, ETC.

FOR A COMPLETE MAINTENANCE SCHEDULE, CHECK YOUR OWNER'S MANUAL

*This is a sample maintenance schedule. Please reference and use your owners manual for full maintenance and vehicle care.

GENERAL TOUGH DOESN'T QUIT

When you invent categories, your work is never finished. We're riders, relentlessly chasing the next ride. It's race-inspired performance that propelled our people to podiums at DAKAR and the Baja 1000, or a crew of relentless explorers who want to break free from the everyday and get deep into the backcountry. Tough doesn't stop when the light fades, tough doesn't settle for second place and tough doesn't quit.



UNCOMPROMISING VERSATILITY TO DO MORE

Experience more outdoors with GENERAL, the bestselling crossover side-by-side built for having fun and getting things done. Take on new trails. Quickly tackle tasks. With exceptional versatility, performance and comfort GENERAL is the ultimate do-it-all machine.



VERSATILITY

TOW. STOW. AND GO. | Bring what you need for outdoor activities with impressive towing capabilities, and a dump box that fits more supplies and gear.



COMFORT

THE RIDE HAS NEVER FELT BETTER | Stay energized on all-day rides with enduring comfort. Responsive steering, up to 34 cm of usable suspension travel and bolstered bucket seats deliver an effortless experience off road.



PERFORMANCE

GET OUT THERE AND THEN SOME | An ideal combination of trail-capable power, terrain-smoothing suspension and ample ground clearance enable near limitless exploration.



GENERAL



CAPABILITY TO MATCH
YOUR AMBITION



GENERAL XP 1000

UNLOCK NEXT-LEVEL VERSATILITY. Elevate your experience with more height from a 64" stance, high clearance A-arms, a 2,041 KG HD Plus winch and available industry-leading technology. Available in 2-seat.

VERSATILITY

272 KG dumping cargo box to haul camping gear or tools

34 CM of ground clearance and 30" tyres to navigate over obstacles

VersaTrac Turf Mode protects your yard while knocking out tasks

COMFORT

35.5 CM of suspension travel smooths out rough trails

Adjustable seats and tilt steering allow you to dial in for the perfect fit

Rockford Fosgate® Premium Audio to bring your favorite music along for the ride*

PERFORMANCE

Ultra-responsive 100 HP engine for corner-to-corner trail exploring fun

2,041 KG winch featuring synthetic rope to clear obstacles when out on the ride

680 KG tow capacity to pull a trailer or drag logs off the trails

True On-Demand AWD/2WD delivers quick gripping traction



GENERAL XP 1000
SPORT

PREPARE FOR THE HUNT



HUNT PACKAGE FEATURED ACCESSORIES:

2881108 Tip-Out Windshield - Glass

2891289  Rear Panel - Glass

2883780 Poly Sport Roof, 2-Seat

2881540 Convex Rearview Mirror

2883126 RIGID® D-Series Pro Flood LED Lights

2884299 RIGID® 32" SR-Series Combo LED Light Bar

2883785 Polaris PULSE LED Light Bar Harness (x2)

2879860 Y-Harness



2883425 Polaris NorthStar 60 QT Cooler

2883166 Pro Armor Wheel & Tyre Set:
5201 & Attack 2.0, 30"

ACCESSORIES THAT WORK HARD



UTILITY PACKAGE FEATURED ACCESSORIES:

- 2884223  Full Vented Windshield - Hard Coat Poly
- 2891288  Rear Panel - Poly
- 2891286 Canvas Upper Doors, 2-Seat
- 2881101 Kick-Out Rock Sliders, 2-Seat

- 2889443 Rhino-Rack® Rear Bed Rack
- 2891204 Rhino-Rack® Eyelet Tie-Downs
- 2885046 Pro Armor Wheel & Tyre Set: 5202 & Harvester, 30"

MAINTENANCE PARTS & FLUIDS

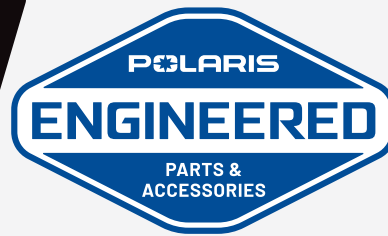

POLARIS ENGINEERED PARTS AND OIL

have been validated and tested extensively, specifically for your vehicle. In order to maintain the peak performance of your Polaris vehicle only use official Polaris Engineered parts and oil.



We're taking the passion of our riders, workers and outdoor enthusiasts to the next level with HD Parts. These Heavy Duty parts are engineered for riders who want greater durability and enhanced performance. HD Parts are designed and tested to handle greater wear and tear under all weather conditions.



A DRIVE BELTS

- » 3211196
GENERAL 1000
- » 3211180
GENERAL XP 1000
- » **HD** • 3212359
GENERAL 1000 / XP 1000



B BRAKE PADS

- » FRONT • 2205949
- » **HD** • FRONT • 2208933
- » REAR • 2203318
- » **HD** • REAR • 2208936



C OIL FILTER

- » 2540086
- » **HD** • 2522498



D BATTERY

- » 4014132-P
- » **HD** • 4081855



E AIR FILTER

- » 7082115



F SPARK PLUG

- » 3022662

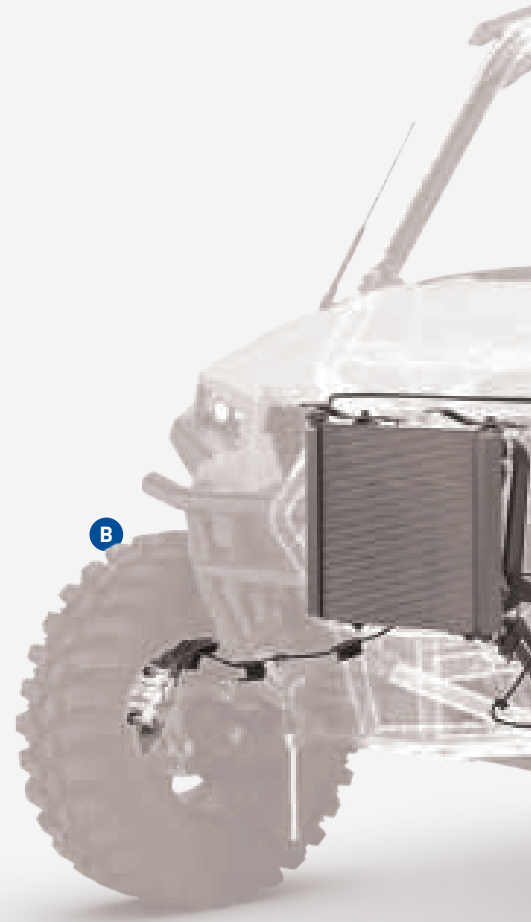

MAINTENANCE SCHEDULE*

BREAK-IN MAINTENANCE

FIRST 25 HRS / 1 MONTH | 250 MI / 400 KM

ENGINE OIL & OIL FILTER
CHANGE

AIR FILTER
INSPECT
REPLACE AS NEEDED

FRONT GEARCASE
INSPECT FLUID
REPLACE AS NEEDED

GENERAL LUBRICATION
ALL FITTINGS, PIVOTS, CABLES, ETC.

6 MONTHS

50 HRS | 500 MI / 800 KM

FRONT GEARCASE
INSPECT FLUID
REPLACE AS NEEDED

DRIVE BELT
INSPECT & ADJUST
REPLACE AS NEEDED

GENERAL LUBRICATION
ALL FITTINGS, PIVOTS, CABLES, ETC.

12 MONTHS

100 HRS | 1,000 MI / 1,600 KM

ENGINE OIL & OIL FILTER
CHANGE

TRANSMISSION & GEARCASE
CHANGE FLUIDS

DRIVE BELT
INSPECT & ADJUST
REPLACE AS NEEDED

AIR FILTER
INSPECT
REPLACE AS NEEDED

18 MONTHS

150 HRS | 1,500 MI / 2,400 KM

ENGINE OIL & OIL FILTER
CHANGE

BATTERY
TEST & CLEAN
REPLACE AS NEEDED

DRIVE BELT
INSPECT & ADJUST
REPLACE AS NEEDED

FRONT GEARCASE
INSPECT FLUID
REPLACE AS NEEDED

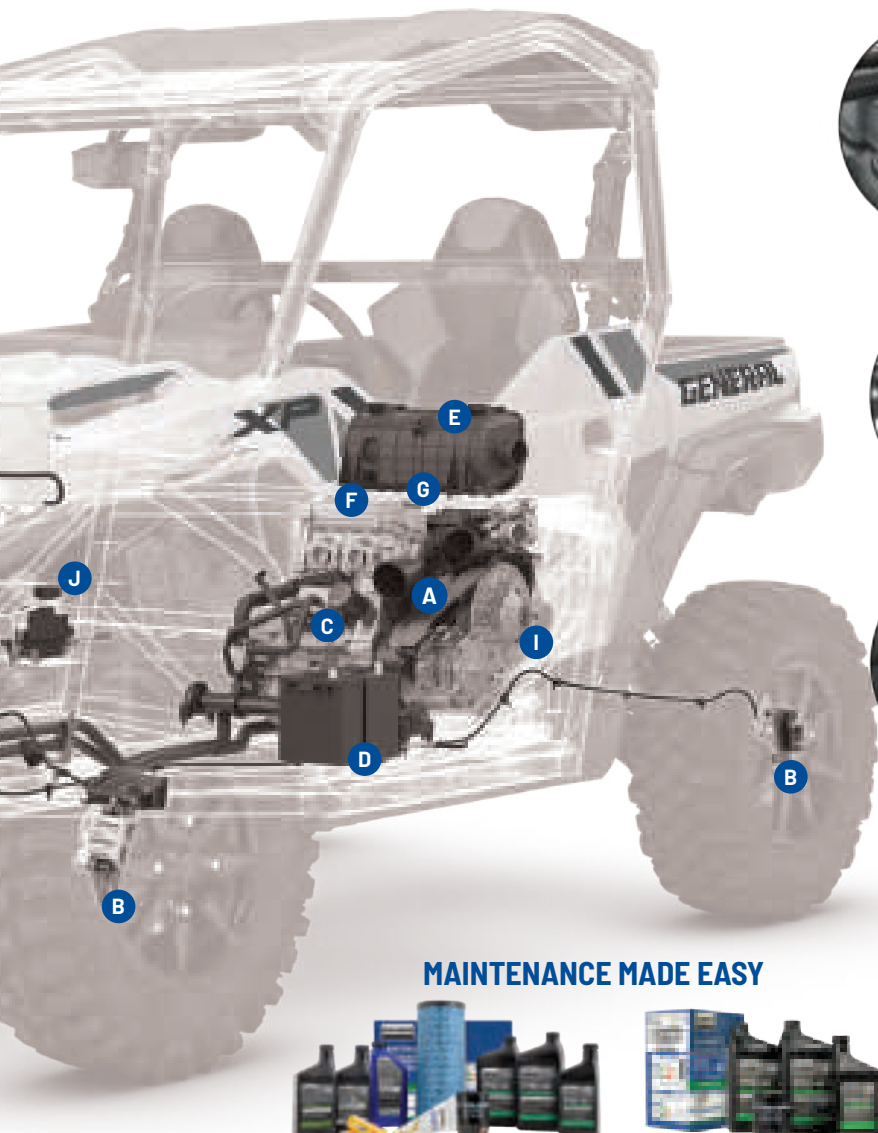

G

ENGINE OIL

- » PS-4 • 1QT • 2876244
- » PS-4 • 1GAL. • 2876245
- » PS-4 EXTREME • 1QT • 2889395
- » PS-4 EXTREME • 1GAL. • 2889396



H

DEMAND DRIVE FLUID

- For front gearcase
- » 1QT • 2877922
 - » 2.5 GAL. • 2877923



I

AGL

- For transmission
- » 1QT • 2878068
 - » 1GAL. • 2878069
 - » EXTREME • 1QT • 2891028



J

DOT 4 BRAKE FLUID

- » 12 OZ • 2872189

MAINTENANCE MADE EASY



ORV MAINTENANCE KIT

Includes Oil Change Kit, Gearcase Fluids, Air Filter, & Spark Plug

» 2830544



OIL CHANGE KITS

2.5 QT Engine Oil (oil varies by kit), 1 Oil Filter (2540086) & 1 Drain Plug Washer

- » PS-4 • 2879323
- » PS-4 EXTREME • 2890057



ALL-SEASON GREASE TUBE

- » 3 OZ • 2871322
- » 14 OZ • 2871423

Claims made based off testing and performance of Polaris HD Parts against standard OEM parts made by Polaris and competitor brands under normal use. For more information regarding Polaris HD parts including vehicle compatibility, installation and maintenance, please contact your authorized Polaris ORV dealer.

24 MONTHS

200 HRS | 2,000 MI / 3,200 KM

- ENGINE OIL & OIL FILTER**
CHANGE
- TRANSMISSION & GEARCASE**
CHANGE FLUIDS
- BRAKE FLUID**
REPLACE
- BRAKE PADS**
INSPECT
REPLACE AS NEEDED
- SPARK PLUGS**
INSPECT
REPLACE AS NEEDED
- AIR FILTER**
INSPECT
REPLACE AS NEEDED

30 MONTHS

250 HRS | 2,500 MI / 4,000 KM

- ENGINE OIL & OIL FILTER**
CHANGE
- BATTERY**
TEST & CLEAN
REPLACE AS NEEDED
- DRIVE BELT**
INSPECT & ADJUST
REPLACE AS NEEDED
- FRONT GEARCASE**
INSPECT FLUID
REPLACE AS NEEDED
- GENERAL LUBRICATION**
ALL FITTINGS, PIVOTS, CABLES, ETC.

36 MONTHS

300 HRS | 3,000 MI / 4,800 KM

- ENGINE OIL & OIL FILTER**
CHANGE
- TRANSMISSION & GEARCASE**
CHANGE FLUIDS
- AIR FILTER**
INSPECT
REPLACE AS NEEDED

FOR A COMPLETE MAINTENANCE SCHEDULE, CHECK YOUR OWNER'S MANUAL

*This is a sample maintenance schedule. Please reference and use your owners manual for full maintenance and vehicle care.

POLARIS
RZR

TOUGH DOESN'T QUIT

When you invent categories, your work is never finished. We're riders, relentlessly chasing the next ride. It's race-inspired performance that propelled our people to podiums at DAKAR and the Baja 1000, or a crew of relentless explorers who want to break free from the everyday and get deep into the backcountry. Tough doesn't stop when the light fades, tough doesn't settle for second place and tough doesn't quit.

DROP TEST // RZR PRO R

POLARIS PROVING GROUNDS



ACCELERATE BEYOND THE EVERYDAY

Everyone is chasing something. A new memory. Connection. A personal best. We enable our riders to wield passion and performance to run down a dream that never planned on being caught. We don't just create machines, we create avenues that allow everyone who sits in a RZR seat to experience the world in a way that amplifies life. And we are intent on pushing that boundary year over year.



RELENTLESS PERFORMANCE

LET IT RIP | RZR's ultimate combination of power and agility, signature riding and handling and fast-engaging On-Demand All-Wheel Drive lets you dominate the world's most challenging environments.



PROVEN DESIGN

THE RETURN OF ICONIC STYLE | Spend more time out riding with durable components that were engineered to push the boundaries and handle the impact of rough terrain.



INDUSTRY-LEADING TECHNOLOGY

TECH THAT CHANGES THE GAME | Unlock an unprecedented riding experience with RIDE COMMAND, Rockford Fosgate® audio systems and the intelligent control of on-the-fly adjustments of DYNAMIX active suspension.



RZR

TRAIL MODELS

AGILITY FOR TIGHT TRAILS



RZR TRAIL S

ULTIMATE TRAIL CAPABILITY. Power through tight trails with a slim 60" width, responsive power, sharp agility and all-day comfort.

PERFORMANCE

Narrow width (60") and slim stance for tight trail navigation

Class-leading power-to-weight ratio for corner-to-corner acceleration

DESIGN

31 cm wheel travel and 27" tyres to soak up the bumps

Adjustable steering and seats for the perfect fit

TECHNOLOGY

7" Display powered by RIDE COMMAND to navigate with ease

Rockford Fosgate® Audio delivers immersive audio on the trail



RZR TRAIL S
ULTIMATE

RZR XP



RZR XP

ROCK SOLID. TRAIL READY. Exceptional performance, durability and quality is in its DNA. RZR XP delivers legendary power, agility and control, unleashing heart-pounding excitement off-road.

PERFORMANCE

ProStar 1000 Gen 2 delivers 114 HP of responsive power

64" width and 228.6 CM wheelbase deliver agility for different terrains

50.8 cm usable travel delivering relentless durability and performance to command

Dial in your ride with three selectable drive modes—Rock, Standard and Sport

Upgraded shifting mechanism to reduce shifting effort

DESIGN

Iconic RZR Fang Lighting

Aggressive Front End Styling

Reinforced half shafts, prop shafts and bearings

7% Stronger Chassis than MY25 RZR XP

30% Stronger Driveline than MY26 RZR XP

TECHNOLOGY

Rockford Fosgate® Stage 3 Audio delivers powerful, clear sound

7" Display powered by RIDE COMMAND to navigate with ease

6 plug-and-play ports for effortless tech accessory installs



RZR XP
SPORT

RZR PRO XP



TAKE ON THE
OFF-ROAD



RZR PRO XP

PUSH YOUR LIMITS ON TOUGH TRAILS. Our most versatile RZR features a 64" width, sharp agility and unrivaled performance for fast-paced rides on tight terrain.

PERFORMANCE

181 HP turbocharged engine unleashes peak power within the 32-to-80 kph range

64" width and 243.8 CM wheelbase deliver the ultimate balance of razor-sharp agility

55 CM of usable suspension travel swallows up bumps for a smoother ride

Pro XP PVT transmission flawlessly handles abrupt trail transitions

Added lower low gear makes it easier to modulate speed

Fast on-demand AWD delivers instant traction

DESIGN

Elevated iconic style

RZR Fang Lighting to stand out from the pack

Solid half doors shrug off more dust

Optimised driver touchpoints bring vehicle controls to your fingertips

Fresh cabin air intakes and radiator deflectors reduce cabin temperatures

TECHNOLOGY

DYNAMIX semi-active suspension independently adjusts each shock's compression damping

Rockford Fosgate® Stage 4 Audio delivers powerful, clear sound

7" Display powered by RIDE COMMAND to navigate with ease



RZR PRO XP
ULTIMATE

RZR

THE RZR PRO LINEUP

The RZR Pro lineup features industry-leading technology, superior fit and finish and animated fang lighting to the Pro R.





REVIVED

- » **BOLD EXTERIOR STYLE** commands respect and catches the eye.
- » **RZR FANG LIGHTING** with dynamic up-and-down animation.
- » **ELEVATED INTERIOR** is generous on comfort and convenience.



REFINED

- » **SOLID HALF DOORS WITH DOUBLE LATCH AND DOOR SEALS** keep the outdoors out.
- » **FRESH CABIN AIR INTAKES** route air into the cab to keep you cooler.
- » **UPDATED DASH** keeps intuitive control at your fingertips.
- » **UPGRADED SEATS AND HARNESES** give you tailored comfort for every ride and route.



NEW! 10.4" TOUCHSCREEN DISPLAY

RELENTLESS

- » **ROCKFORD FOSGATE® STAGE 4 AUDIO** makes for easy playback and quality sound on the trail.
- » **RIDE COMMAND** Easily map routes, monitor your machine, switch tunes and more, without taking your focus from the ride.
- » **DYNAMIX DV (PRO R)** semi-active suspension individually adjusts each shock's compression and rebound on the fly.

RZR

WIDE-OPEN MODELS



PERFORMANCE FOR THE
TOUGHEST TERRAIN



RZR PRO R

CHAMPION OF THE DESERT. Heart-pounding performance to defy deserts, conquer dunes and break off-road records. Available in 2-seat and 4-seat.

PERFORMANCE

225 HP, ProStar Fury 2.0 naturally aspirated 4-cylinder engine unleashes relentless power

74" stance and 265 CM wheelbase for maximum stability

MaxLink suspension with 68 CM of usable travel that devours whoops

Race-proven driveline components to defy deserts and conquer dunes

Strong belt and oversized clutch handle high-torque environments

Pro Performance True 4WD provides instant traction

DESIGN

Elevated iconic style

RZR Fang Lighting to stand out from the pack

Solid half doors shrug off more dust

Optimised driver touchpoints bring vehicle controls to your fingertips

Fresh cabin air intakes and radiator reflectors reduce cabin temperatures

One-piece welded chassis with 2" tubing and tapered joints for added strength where it joins the chassis

TECHNOLOGY

DYNAMIX DV semi-active suspension independently adjusts each shock's rebound and compression damping

Rockford Fosgate® Stage 4 Audio delivers powerful, clear sound

NEW 10.4" Touchscreen Display powered by RIDE COMMAND to navigate with ease



RZR PRO R
ULTIMATE



RZR PRO R 4
ULTIMATE

RZR TRAIL S ACCESSORIES

POLARIS RZR TRAIL S



► EXPLORER PACKAGE

2889537	Tip Out Windshield - Hard Coat Poly	2884871*	Accent Lights
2884729	 Poly Sport Roof	2883763	Premium Convex Rearview Mirror
2884912	Stage 1 PMX Audio Kit by Rockford Fosgate®	2884524	Adjustable Folding Side Mirrors
2883945	Rear Speaker Pods by Rockford Fosgate®	2883123	RIGID® SR-Series 10" Combo LED Light
2415652	Rear Speaker Pod Audio Harness	2884657	Light Bar Harness
2884732-458	Front High Coverage Bumper	5416340**	Pro Armor Spare Tyre: Dual Threat, 26"
2884734-458	Rear Bumper Extension	1523283	Pro Armor Spare Wheel: 4301 Beadlock, 14"
2884762	Spare Tyre Carrier	2883216**	Pro Armor Wheel & Tyre Set: 4301 Beadlock & Dual Threat, 26"

> TRAILBLAZER PACKAGE





- 2884911  Full Vented Windshield - Hard Coat Poly
- 2884765  Poly Rear Panel
- 2884761-458 Aluminum Roof
- 2884868-458 Front Winch Bumper
- 2884734-458 Rear Bumper Extension
- 2879456-458 Kick-Out Rock Sliders
- 2881985 Full Coverage Fender Flares
- 2881193  69 QT Cargo Box
- 2891731 Pro Series 4,500 LB Winch
- 2883763 Premium Convex Rearview Mirror
- 2884524 Adjustable Folding Side Mirrors
- 2879332 12MM x 1.5 Splined Lug Nuts with Wrench Adapter
- 2883157 Pro Armor Wheel & Tyre Set: 5202 & Attack 2.0, 28"

Shown on Trail S Sport. Applicable to all models with adjustments.

> ADVENTURER PACKAGE





- 2884756 Full Vented Windshield - Glass
- 2884755 Windshield Wiper - Washer Kit
- 2884765  Poly Rear Panel
- 2884729  Poly Sport Roof
- 2884733 Canvas Upper Doors, 60"
- 2884917 Factory Audio Stage 3 Upgrade by Rockford Fosgate®
- 2884019-293 Front Low Profile Bumper
- 2881587-293 Low Profile Rock Sliders
- 2881556  51 QT Cooler Box
- 2884735 Heater Kit
- 2891731 Pro Series 4,500 LB Winch
- 2884648 RIGID® SR-Series 32" Combo LED Light Bar
- 2884650 32" Light Bar Mount
- 2884657 Light Bar Harness
- 2884183 Polaris PULSE Underhood Bus Bar - 6 Position
- 2883763 Premium Convex Rearview Mirror
- 1522240 15" Forged Beadlock Ring
- 2879332 12MM x 1.5 Splined Lug Nuts with Wrench Adapter
- 2883182 Pro Armor Wheel & Tyre Set: 5203 Beadlock & Crawler XG, 28"

Shown on Trail S Ultimate. Applicable to all models with adjustments.

POLARIS RZR XP





> TRAIL PACKAGE

2884562	Stage 4 Audio Upgrade by Rockford Fosgate®	2889293	Chase Light Harness Kit
2884542	 Full Vented Windshield - Hard Coat Poly	2884530	8.5 QT Shoulder Storage Bag
2884519	 Rear Panel - Hard Coat Poly	2884528	5 QT Door Storage Bag
2884554*	Poly Sport Roof, 4-Seat	2884548	Tonneau Cover
2891276-458	Front High Coverage Bumper	2891279-458	Pivoting Spare Tyre Carrier
2884514-293	Rear High Coverage Bumper	2883763	Premium Convex Rearview Mirror
2884512-293	Heavy Duty Kick-Out Rock Sliders, 4-Seat	2891232	Pro Armor Side Mirrors
2884648	RIGID® SR-Series 32" Combo LED Light Bar	2891063*	Pro Series 4,500 LB Winch
2884650	32" Light Bar Mount	5415616	Pro Armor Spare Tyre: Crawler XG, 30"
2889291	Polaris PULSE Light Bar Harness	5418036	Pro Armor Spare Wheel: 4302 Beadlock, 14"
2884359	RIGID® Chase Light	2889555	Pro Armor Wheel & Tyre Set: 4302 Beadlock & Crawler XG, 30"
2889121	Chase Light Mount Kit		



➤ BACKCOUNTRY PACKAGE

- | | | | |
|-------------|---|-------------|--|
| 2889614 | Stage 5 Audio Upgrade by Rockford Fosgate® | 2889293 | Chase Light Harness Kit |
| 2884542 |  Full Vented Windshield - Hard Coat Poly | 2889611 |  77 L Forward Cargo Box |
| 2884549-293 | Aluminum Roof, 2-Seat | 2884530 | 8 L Shoulder Storage Bag |
| 2884472-293 | Low Profile Rock Sliders, 2-Seat | 2889612 |  28 QT Rear Cooler |
| 2884648 | RIGID® SR-Series 32" Combo LED Light Bar | 2891279-458 | Pivoting Spare Tyre Carrier |
| 2884650 | 32" Light Bar Mount | 2883763 | Premium Convex Rearview Mirror |
| 2889291 | Polaris PULSE Light Bar Harness | 2891232 | Pro Armor Side Mirrors |
| 2884359 | RIGID® Chase Light | 5417533 | Pro Armor Spare Tyre: Pro Runner, 33" |
| 2889121 | Chase Light Mount Kit | 1525688 | Pro Armor Spare Wheel: 5307 Beadlock, 15" |
| | | 2890975 | Pro Armor Wheel & Tyre Set: 5307 Beadlock & Pro Runner, 33" |





RZR PRO XP ACCESSORIES

POLARIS

RZR PRO XP



➤ TRAIL PACKAGE

- | | | | |
|-------------|---|-------------|---|
| 2890375 |  Full Vented Windshield - Hard Coat Poly | 2883752 |  39 L Rear Cargo Box |
| 2891091 |  Rear Panel - Hard Coat Poly, 2-Seat | 2889785 | 9.5 L Shoulder Storage Bag |
| 2890430-458 | Aluminum Roof, 2-Seat | 2889404-458 | Pivoting Spare Tyre Carrier |
| 2890388-458 | Front High Coverage Bumper | 2883763 | Premium Convex Rearview Mirror |
| 2891234-458 | Rear High Coverage Bumper | 2891232 | Pro Armor Side Mirrors |
| 2890396-458 | Heavy Duty Kick-Out Rock Sliders, 2-Seat | 2891659 | Pro Series 2,041 KG Winch |
| 2884648 | RIGID® SR-Series 32" Combo LED Light Bar | 2884684 | Pro Armor Rock Lights, Blue |
| 2884650 | 32" Light Bar Mount | 5418676 | Pro Armor Spare Tyre: Trekker, 30" |
| 2889130 | Polaris PULSE High Current Light Bar Harness | 1525455 | Pro Armor Spare Wheel: 5305 Beadlock, 15" |
| 2883751 |  69 L Forward Cargo Box | 2890912 | Pro Armor Wheel & Tyre Set: 5305 Beadlock & Trekker, 30" |



» BACKCOUNTRY PACKAGE



2889710	Audio Roof by Rockford Fosgate®, 2-Seat	2889404-458	Pivoting Spare Tyre Carrier
2890374	 Half Windshield - Hard Coat Poly	2883763	Premium Convex Rearview Mirror
2890389-293	Front Low Profile Bumper	2884347	Secondary Battery Mount Kit
2890396-293	Heavy Duty Kick-Out Rock Sliders, 2-Seat	2891659	Pro Series 4,500 LB Winch
2884359	RIGID® Chase Light	4014609	Polaris Engineered Battery
2884896	Chase Light Mount Kit	5417531	Pro Armor Spare Tyre: Pro Runner, 30"
2890052	Chase Light Harness Kit	1525454	Pro Armor Spare Wheel: 5208, 15"
2883752	 42 QT Rear Cargo Box	2890176	Pro Armor Wheel & Tyre Set: 5208 & Pro Runner, 30"
2883424	Polaris NorthStar 30 QT Cooler	2890429	Off-Road Tool Kit by CruzTOOLS®
2884070	 NorthStar 30 QT Cooler Bracket		

RZR PRO R ACCESSORIES

POLARIS RZR PRO R





> DUNE PACKAGE

3880099	Stage 6 Audio Kit (Ultimate) by Rockford Fosgate®	2884236	 34 L Rear Cargo Box
2891017	GatorStep® Premium Roof Liner, 2-Seat	2883424	Polaris NorthStar 27 L Cooler
2891019	GatorStep® Front Armrest Pads	2889200	 NorthStar 27 L Cooler Bracket
2890391-887	Front Low Profile Bumper	2889785	9 L Shoulder Storage Bag
2891093-887	Pro Armor Aluminum Front Grille	2883763	Premium Convex Rearview Mirror
2884648	RIGID® SR-Series 32" Combo LED Light Bar	2891232	Pro Armor Side Mirrors
2884601	32" Light Bar Mount	2889795	Pro Armor 2x2" Cube LED Spot Lights (2)
2889130	Polaris PULSE High Current Light Bar Harness (x2)	2412616	Adapter Harness
2884359	RIGID® Chase Light	2879860	LED Y-Harness
2884896	Chase Light Mount Kit	2885020	Pro Armor Wheel & Tyre Set: 5207/5303 & Sand 16XT, 32"
2890052	Chase Light Harness Kit		



> DESERT PACKAGE

2890391-293	Front Low Profile Bumper	2890863-458	Pivoting Spare Tyre Carrier
2884648	RIGID® SR-Series 32" Combo LED Light Bar	2883763	Premium Convex Rearview Mirror
2884601	32" Light Bar Mount	5417174	Pro Armor Spare Tyre: Crawler XR, 33"
2889130	Polaris PULSE High Current Light Bar Harness	1525688-458	Pro Armor Spare Wheel: 5307 Beadlock, 15"
2884359	RIGID® Chase Light	2890983	Pro Armor Wheel & Tyre Set: 5307 Beadlock & Crawler XR, 33"
2884896	Chase Light Mount Kit		
2890052	Chase Light Harness Kit		
2884235	 56 L Forward Cargo Box		
2889740	 21 L Rear Cooler		
2889785	9 L Shoulder Storage Bag		

MAINTENANCE PARTS & FLUIDS

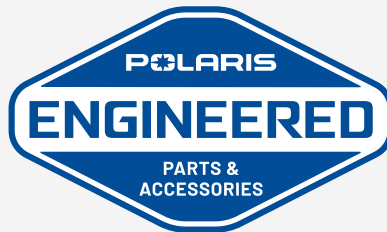

POLARIS ENGINEERED PARTS AND OIL have been validated and tested extensively, specifically for your vehicle. In order to maintain the peak performance of your Polaris vehicle only use official Polaris Engineered parts and oil.



We're taking the passion of our riders, workers and outdoor enthusiasts to the next level with HD Parts. These Heavy Duty parts are engineered for riders who want greater durability and enhanced performance. HD Parts are designed and tested to handle greater wear and tear under all weather conditions.



A DRIVE BELT

- » 3211202
PRO XP, PRO S
- » **HD** • 3212358
PRO XP, PRO S
- » 3211226
PRO R



B BRAKE PADS

- » FRONT • 2208162
PRO XP
- » FRONT • 2211640
PRO R, PRO S
- » REAR • 2208161
PRO XP
- » REAR • 2211643
PRO R, PRO S



C OIL FILTER

- » 2520799
PRO XP, PRO S
- » **HD** • 2522485
PRO XP, PRO S
- » 2521728
PRO R



D BATTERY

- » 4014609



E AIR FILTER

- » 1241084
PRO XP, PRO S
- » **HD** • 2882234
PRO XP, PRO S
- » 7082436
PRO R



F SPARK PLUGS

- » 3023173
PRO XP, PRO S
- » 3023413
PRO R

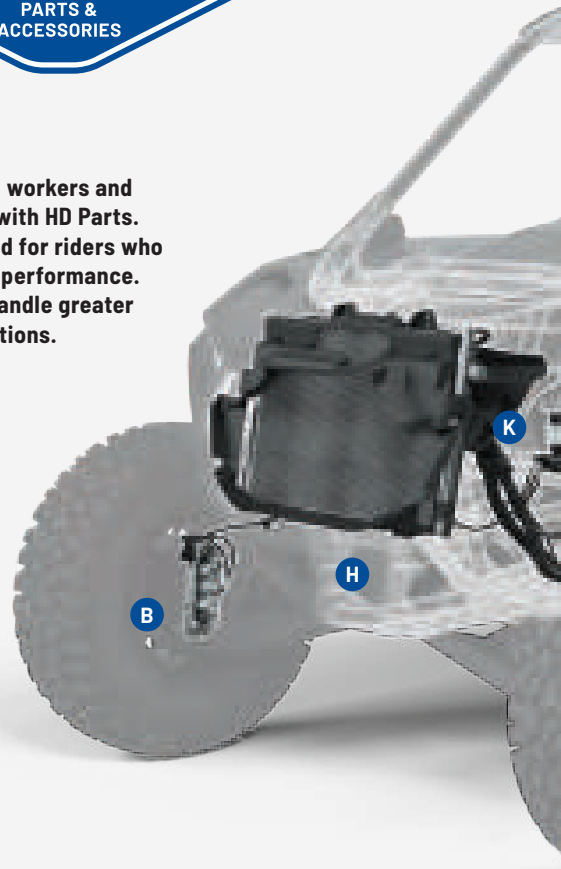

MAINTENANCE SCHEDULE*

BREAK-IN MAINTENANCE

FIRST 25 HRS | 250 MI / 400 KM

- ENGINE OIL & OIL FILTER**
CHANGE
- AIR FILTER**
INSPECT
REPLACE AS NEEDED
- BATTERY**
TEST, CLEAN
REPLACE AS NEEDED
- FRONT GEARCASE**
INSPECT
ADD FLUID AS NEEDED
- TRANSMISSION**
INSPECT FLUID
ADD FLUID AS NEEDED
- GENERAL LUBRICATION**
ALL FITTINGS, PIVOTS, CABLES, ETC.

6 MONTHS

25 HRS | 500 MI / 800 KM

- AIR FILTER**
INSPECT
REPLACE AS NEEDED
- BRAKE PADS**
INSPECT
REPLACE AS NEEDED
- BRAKE FLUID**
INSPECT
ADD AS NEEDED
- BATTERY**
TEST & CLEAN
REPLACE AS NEEDED

12 MONTHS

50 HRS | 1,000 MI / 1,600 KM

- ENGINE OIL & OIL FILTER**
CHANGE
- PRO XP**
TRANSMISSION
CHANGE FLUID
- FRONT GEARCASE**
CHANGE FLUID
- AIR FILTER**
INSPECT
REPLACE AS NEEDED
- BRAKE PADS**
INSPECT
REPLACE AS NEEDED
- BRAKE FLUID**
INSPECT
ADD AS NEEDED
- DRIVE BELT**
INSPECT & ADJUST
REPLACE AS NEEDED
- BATTERY**
TEST & CLEAN
REPLACE AS NEEDED

18 MONTHS

150 HRS | 1,500 MI / 2,400 KM

- AIR FILTER**
INSPECT
REPLACE AS NEEDED
- BRAKE PADS**
INSPECT
REPLACE AS NEEDED
- BRAKE FLUID**
INSPECT
ADD AS NEEDED
- BATTERY**
TEST & CLEAN
REPLACE AS NEEDED

RZR PRO R & PRO XP

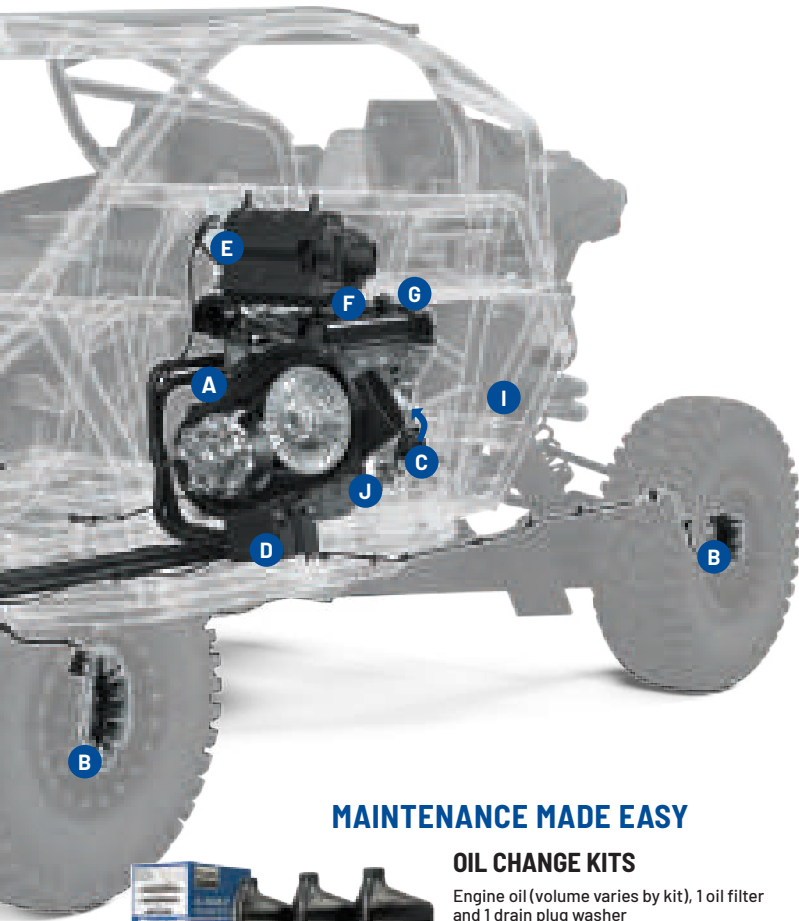

MAINTENANCE MADE EASY

OIL CHANGE KITS

Engine oil (volume varies by kit), 1 oil filter and 1 drain plug washer

» PS-4 • 2881696
PRO XP, PRO S

» PS-4 EXTREME • 2890058
PRO XP, PRO S

» PS-4 • 2890880
PRO R

» PS-4 EXTREME • 2890881
PRO R



G ENGINE OIL

- » PS-4 • 1 QT • 2876244
- » PS-4 • 1 GAL. • 2876245
- » PS-4 EXTREME • 1 QT • 2889395
- » PS-4 EXTREME • 1 GAL. • 2889396



H DEMAND DRIVE FLUID

For front gearcase

- » 1 QT • 2877922
- » 2.5 GAL. • 2877923
PRO XP, PRO S



I ANGLE DRIVE FLUID

For front and rear gearcase

- » 1 QT • 2889280
PRO R



J AGL

For transmission

- » 1 QT • 2878068
- » 1 GAL. • 2878069
- » EXTREME • 1 QT • 2891028



K DOT 4 BRAKE FLUID

- » 12 OZ • 2872189

ALL-SEASON GREASE TUBE 3 OZ • 2871322

- » 14 OZ • 2871423



Claims made based off testing and performance of Polaris HD Parts against standard OEM parts made by Polaris and competitor brands under normal use. For more information regarding Polaris HD parts including vehicle compatibility, installation and maintenance, please contact your authorized Polaris ORV dealer.

24 MONTHS

200 HRS | 2,000 MI / 3,200 KM

ENGINE OIL & OIL FILTER
CHANGE

PRO XP
TRANSMISSION
CHANGE FLUID

FRONT GEARCASE
CHANGE FLUID

AIR FILTER
INSPECT
REPLACE AS NEEDED

BRAKE PADS
INSPECT
REPLACE AS NEEDED

BRAKE FLUID
INSPECT
ADD AS NEEDED

DRIVE BELT
INSPECT & ADJUST
REPLACE AS NEEDED

BATTERY
TEST & CLEAN
REPLACE AS NEEDED

30 MONTHS

250 HRS | 2,500 MI / 4,000 KM

AIR FILTER
INSPECT
REPLACE AS NEEDED

BRAKE PADS
INSPECT
REPLACE AS NEEDED

BRAKE FLUID
INSPECT
ADD AS NEEDED

BATTERY
TEST & CLEAN
REPLACE AS NEEDED

36 MONTHS

300 HRS | 3,000 MI / 4,800 KM

ENGINE OIL & OIL FILTER
CHANGE

PRO XP
TRANSMISSION
CHANGE FLUID

FRONT GEARCASE
CHANGE FLUID

AIR FILTER
INSPECT
REPLACE AS NEEDED

BRAKE PADS
INSPECT
REPLACE AS NEEDED

BRAKE FLUID
INSPECT
ADD AS NEEDED

DRIVE BELT
INSPECT & ADJUST
REPLACE AS NEEDED

BATTERY
TEST & CLEAN
REPLACE AS NEEDED

FOR A COMPLETE MAINTENANCE SCHEDULE, CHECK YOUR OWNER'S MANUAL

YOUTH SIDE-BY-SIDE & ATV

INSPIRE CONFIDENCE OFF-ROAD



Empower child riders to take their own off-road adventures with youth vehicles built for comfort and control. Our kids' off-road lineup features a small quad and side-by-side designed for a range of children's ages and experience levels—all with industry-leading safety features.



SAFETY FEATURES PARENTS LOVE

SAFE AND SOUND | Enjoy peace of mind knowing that Polaris youth models come with industry-leading safety features designed to build a solid foundation for the next generation of riders.



KID-FRIENDLY PERFORMANCE

HAVE A DAY | Kids can confidently tackle adventures thanks to age-appropriate ergonomics, capable suspension and plenty of ground clearance to clear obstacles.



GROW WITH POLARIS

RIDE EARLY. RIDE OFTEN. | We build confidence-inspiring youth model ATVs and side-by-sides. We offer a quad and side-by-side for riders aged 10+.



YOUTH SIDE-BY-SIDE & ATV

KID-FRIENDLY PERFORMANCE



RZR 200 EFI

SXS PERFORMANCE FOR THE NEXT GENERATION. Give kids RZR performance and empower them while fostering a love for outdoors with leading safety technology parents will appreciate like Helmet Aware, kid-friendly performance and power that grows with them. The RZR 200 is made for riders ages 10+ with adult supervision.

RZR 200 EFI

- 180cc 4-stroke single cylinder engine
- 25.4 CM ground clearance
- 24" tyres
- 48" wide
- Adjustable Speed Limiter
- Geofencing
- Age: 10+





OUTLAW 110 EFI

INSPIRING CONFIDENCE OFF ROAD. The outlaw is perfect to introduce young riders to riding the trails. The Outlaw 110 model are made for riders ages 10+ with adult supervision.

OUTLAW 110 EFI

112cc 4-stroke single cylinder engine

3.5" ground clearance

36.75" wide

Adjustable speed limiter

Age: 10+



» YOUTH ACCESSORIES

200 EFI



LR FULL WINDSHIELD

- Made of durable polycarbonate to protect the cab from dust, rain and wind
- Lock & Ride offers easy, toolless installation
- Integrates with the roof to prevent rain from entering the cab

» 2884570
200 EFI '22-26



LR HALF WINDSHIELD

- Made of durable polycarbonate to protect the cab from dust, rain and wind
- Lock & Ride offers easy, toolless installation
- Fully seals at the base for lower protection from the elements, while the open top-half enables airflow

» 2884571
200 EFI '22-26



POLY REAR PANEL

- Made of durable .25" polycarbonate, which offers rider protection and visibility
- Installs quickly and easily with P-clamps
- Features scratch-resistant hard coating for enhanced durability

» 2889777
200 EFI '22-26



BUMPERS

- Made of durable steel to provide great protection
- Chassis integrated mounting
- Front bumper offers integrated tow hook

» FRONT • 2884577
200 EFI '22-26

» REAR • 2885144
200 EFI '22-26



ROCK SLIDERS

- Add durable protection from rocks or stumps
- Chassis integrated mounting for easy install
- Comes with two steel rock sliders

» 2885146
200 EFI '22-26



REAR STORAGE BAG

- 3 L storage capacity
- Mounts to rear ROPS with a Velcro® wrap
- Made to withstand the elements and wear with durable ballistic nylon construction

» 2885145
200 EFI '22-26



PRO ARMOR YOUTH SAND 8XT TYRE

- 8 paddles for optimized performance
- Wider rear tyres for better traction, grip and flotation on the sand

» FRONT • 24" x 8" R12 • 5418458

» REAR • 24" x 10" R12 • 5418459
200 EFI '22-26



PRO ARMOR YOUTH CRAWLER TYRE

- 25" design provides additional ground clearance
- Improved performance in all types of applications, from rock crawling to desert running
- Double-belted sidewall for additional puncture-resistance

» FRONT/REAR • 25" x 9.5" R12 • 5417953

200 EFI '22-26



PRO ARMOR WHEEL & TYRE SET: COMBAT & YOUTH SAND 8XT

- Not compatible with stock lug nuts; Requires metric lug nuts (2877384, 2877385), sold separately

» FOUR WHEELS & TYRES • 2890260

200 EFI '22-26

MAINTENANCE PARTS & FLUIDS

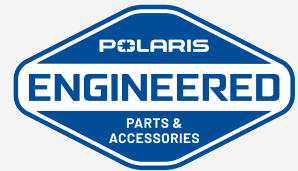

POLARIS ENGINEERED PARTS AND OIL have been validated and tested extensively, specifically for your vehicle. In order to maintain the peak performance of your Polaris vehicle only use official Polaris Engineered parts and oil.



POLY ROOF

- Durable HDPE material provides protection from the weather
- 4-bolt installation
- Integrates with full windshield to provide complete cab coverage

» 2889739

200 EFI '22-26



PRO ARMOR YOUTH COMBAT WHEEL

- Designed specifically for youth vehicles
- Increased strength and lightweight performance helps overcome obstacles on the trail
- Not compatible with stock lug nuts; Requires metric lug nuts (2877384, 2877385), sold separately

» FRONT • 12" x 7" • 1525222

200 EFI '22-26

» REAR • 12" x 7" • 1525421

200 EFI '22-26



PRO ARMOR WHEEL & TYRE SET: COMBAT & YOUTH CRAWLER

- Not compatible with stock lug nuts; Requires metric lug nuts (2877384, 2877385), sold separately

» FOUR WHEELS & TYRES • 2889869

200 EFI '22-26



DRIVE BELT

» 3050270



BRAKE PADS

» FRONT • 2208176
» REAR • 2209841



OIL FILTER

» 3023344



BATTERY

» 4011434

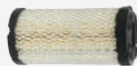

AIR FILTER

» 7082249



SPARK PLUG

» 3050051



ENGINE OIL

» FIND ME!!!



AGL

» 1 QT • 2878068
» 1 GAL. • 2878069
» EXTREME • 1 QT • 2891028



DOT 4 BRAKE FLUID

» 12 OZ • 2872189



ALL-SEASON GREASE TUBE

» 3 OZ • 2871322
» 14 OZ • 2871423

MAINTENANCE SCHEDULE*

BREAK-IN MAINTENANCE

FIRST 12 HRS | 100 MI / 160 KM

ENGINE OIL & OIL FILTER
CHANGE

BRAKE FLUID
INSPECT
ADD AS NEEDED

BRAKE PADS
INSPECT
REPLACE AS NEEDED

6 MONTHS

50 HRS | 500 MI / 800 KM

ENGINE OIL & OIL FILTER
CHANGE

BATTERY
CLEAN & TEST
REPLACE AS NEEDED

GENERAL LUBRICATION
ALL FITTINGS, PIVOTS,
CABLES, ETC.
REPEAT EVERY 6 MONTHS

12 MONTHS

100 HRS | 1000 MI / 1600 KM

ENGINE OIL & OIL FILTER
CHANGE

TRANSMISSION
CHANGE FLUID

AIR FILTER
REPLACE

BRAKE FLUID/ BRAKE PADS
INSPECT
ADD AS NEEDED / REPLACE AS NEEDED

DRIVE BELT / SPARK PLUGS
INSPECT
REPLACE AS NEEDED

BATTERY
CLEAN & TEST
REPLACE AS NEEDED

*This is a sample maintenance schedule. Please reference and use your owners manual for full maintenance and vehicle care.



RANGER 500

ENGINE TYPE / HP	567 cc, 4-Stroke DOHC, Single Cylinder / 28 HP
DRIVETRAIN (DRIVE SYSTEM)	AWD with Auto-Locking Front Drive Selectable VersaTrac Turf Mode
FRONT/REAR SUSPENSION	MacPherson Strut 9" (22.9 cm) Travel / Dual A-Arm, IRS 10" (25.4 cm) Travel
FRONT TYRES & REAR TYRES	25 x 8-12; Carlstar 489 25 x 10-12; Carlstar 489
OVERALL VEHICLE SIZE (L X W X H)	279.4 x 148.6 x 190 cm
GROUND CLEARANCE	25.4 cm
SEATING CAPACITY	2
BOX CAPACITY	227 KG
TOW CAPACITY	680 KG
OTHER STANDARD FEATURES	4" LCD Rider Information Center, 2,500 LB Winch with Wired Remote, Steel Front Bumper with Integrated Winch Mount



RANGER SP 570 HD

ENGINE TYPE / HP	567cc, 4-Stroke DOHC, Single Cylinder / 44 HP
DRIVETRAIN (DRIVE SYSTEM)	On-Demand True AWD/2WD/VersaTrac Turf Mode
FRONT/REAR SUSPENSION	MacPherson Strut 9" (22.9 cm) Travel / Dual A-Arm, IRS 10" (25.4 cm) Travel
FRONT TYRES & REAR TYRES	25 x 8-12; Carlstar 489 25 x 10-12; Carlisle 489
OVERALL VEHICLE SIZE (L X W X H)	274.3 x 142.2 x 188 cm
GROUND CLEARANCE	27.9 cm
SEATING CAPACITY	2
BOX CAPACITY	227 KG
TOW CAPACITY	680 KG
OTHER STANDARD FEATURES	Gas Assist Dump Box, Single Latch Tailgate, Full Coverage Steel Front Bumper with Integrated Winch and Plow Mounts, Full Coverage Skid Plate, Premium Cut and Sew Seats, Polaris Pulse Electrical System (3 position), USB Charging Port, Rear Wheel Liners, Active Descent Control (ADC), Handbrake.



RANGER 1000 PREMIUM

ENGINE TYPE / HP	999cc, 4-Stroke SOHC, Twin Cylinder / 61 HP	
DRIVETRAIN (DRIVE SYSTEM)	High Performance On-Demand True AWD/2WD/ VersaTrac Turf Mode	
FRONT/REAR SUSPENSION	Dual A-Arm 10" (25.4 cm) Travel / Dual A-Arm, IRS 10" (25.4 cm) Travel	
FRONT TYRES & REAR TYRES	26 x 9-12; PXT 2.0 26 x 11-12; PXT 2.0	
OVERALL VEHICLE SIZE (L X W X H)	305 x 158 x 198 cm	386 x 158 x 198 cm
GROUND CLEARANCE	31.8 cm	
SEATING CAPACITY	3 / 6	
BOX CAPACITY	454 KG	
TOW CAPACITY	1,134 KG	
OTHER STANDARD FEATURES	2,041 KG Synthetic Rope Winch with Autostop and Wireless Remote, Factory-Installed Poly Sport Roof, Premium Cut and Sew Bench Seat, Front Bumper with Integrated Plow and Winch Mounts, Single Latch Cab Nets, Polaris Pulse Electrical System (3 position), 12V Accessory Outlet, Battery Trickle-Charging Outlet	



RANGER XP 1000 / CREW HD / PREMIUM

ENGINE TYPE / HP	999cc, 4-Stroke DOHC, Twin Cylinder / 82 HP	
DRIVETRAIN (DRIVE SYSTEM)	High Performance On-Demand True AWD/2WD/ VersaTrac Turf Mode	
FRONT/REAR SUSPENSION	Dual A-Arm 10" (25.4 cm) Travel / Dual A-Arm, IRS 10" (25.4 cm) Travel	
FRONT TYRES & REAR TYRES	29 x 9-14; Pro Armor X-Terrain 29 x 11-14; Pro Armor X-Terrain	
OVERALL VEHICLE SIZE (L X W X H)	305 x 158 x 201 cm	386 x 158 x 201 cm
GROUND CLEARANCE	35.5 cm	
SEATING CAPACITY	3 / 6	
BOX CAPACITY	454 KG	
TOW CAPACITY	1,134 KG	
OTHER STANDARD FEATURES	Front Bumper with Integrated Winch, Plow and LED Mounts, Premium Cut and Sew Seats with Contoured Seatbacks and Embroidered Polaris Branding, 2,041 KG Synthetic Rope Winch with Autostop and Wireless Remote, Factory-Installed Poly Sport Roof, Polaris Pulse Electrical System (6 position), 12V Accessory Outlet, Battery Trickle-Charging Outlet, USB Outlet. Heavy Duty (HD) comes with Active Descent Control (ADC) & Handbrake.	



RANGER DIESEL
HD

ENGINE TYPE / HP	Kubota 3-cylinder diesel / 24 HP
DRIVETRAIN (DRIVE SYSTEM)	High-performance on-demand true AWD/2WD/VersaTrac Turf Mode
FRONT/REAR SUSPENSION	Dual A-Arm 10" (25.4 cm) Travel / Dual A-arm, 10" (25.4 cm) travel
FRONT TYRES & REAR TYRES	27 x 9-14; Pro Armor X Terrain with Variable Tread Pattern 27 x 11-14; Pro Armor X Terrain with Variable Tread Pattern
OVERALL VEHICLE SIZE (L X W X H)	305 x 159 x 195 cm
GROUND CLEARANCE	33 cm
SEATING CAPACITY	3
BOX CAPACITY	454 KG
TOW CAPACITY	1,134 KG
OTHER STANDARD FEATURES	4" LCD rider information centre, 140 Amps Charging System, Gas-assist dump box with Lock & Ride accessory integration, High-output EPS, 3-person, bolstered bench seat with 3-point harness and adjustable driver seat Active Descent Control (ADC), Handbrake.



2024 RANGER XP KINETIC
ULTIMATE

ENGINE TYPE / HP	Internal Permanent Magnet AC Motor / 110 HP
DRIVETRAIN (DRIVE SYSTEM)	High Performance On-Demand True AWD/2WD/VersaTrac Turf Mode
FRONT/REAR SUSPENSION	Dual A-Arm 10" (25.4 cm) Travel / Dual A-Arm, IRS 10" (25.4 cm) Travel
FRONT TYRES & REAR TYRES	29 x 9-14; Pro Armor X-Terrain 29 x 11-14; Pro Armor X-Terrain
OVERALL VEHICLE SIZE (L X W X H)	305 x 158 x 198 cm
GROUND CLEARANCE	35.6 cm
SEATING CAPACITY	3
BOX CAPACITY	567 KG
TOW CAPACITY	1,134 KG
OTHER STANDARD FEATURES	7" Display Powered by RIDE COMMAND, Premium Cut and Sew Seats with Contoured Seatbacks and Embroidered Polaris Branding, Premium Steering Wheel and Interior Accents, Polaris Pulse Electrical System (6 position), DC Outlet, Dual USB Port, 12V Cargo Box Power Port



RANGER XP 1000 / CREW
NORTHSTAR PREMIUM

ENGINE TYPE / HP	999cc, 4-Stroke DOHC, Twin Cylinder / 82 HP
DRIVETRAIN (DRIVE SYSTEM)	High Performance On-Demand True AWD/2WD/ VersaTrac Turf Mode
FRONT/REAR SUSPENSION	Dual A-Arm 10" (25.4 cm) Travel / Dual A-Arm, IRS 10" (25.4 cm) Travel
FRONT TYRES & REAR TYRES	29 x 9-14; Pro Armor X-Terrain 29 x 11-14; Pro Armor X-Terrain
OVERALL VEHICLE SIZE (L X W X H)	305 x 165 x 201 cm
GROUND CLEARANCE	35.5 cm
SEATING CAPACITY	3 / 6
BOX CAPACITY	454 KG
TOW CAPACITY	1,134 KG
OTHER STANDARD FEATURES	Premium Enclosed Cab, Doors with Powered Front Windows, Tip-Out Glass Windshield with Wiper, Rear Glass Panel, Factory-Installed Heat, AC, Defrost, Rear View Mirror, NorthStar Tailgate Badge, Front Bumper with Integrated Winch, PLOW and LED Mounts, Premium Cut and Sew Seats with Contoured Seatbacks and Embroidered Polaris Branding, 2,041 KG Synthetic Rope Winch with Autostop and Wireless Remote, Polaris Pulse Electrical System (6-Position) Underhood Busbar and 6-Position Roof Busbar, 12V Accessory Outlet, Battery Trickle-Charging Outlet, USB Outlet



RANGER XD 1500 / CREW
NORTHSTAR ULTIMATE

ENGINE TYPE / HP	1498cc, 4-Stroke DOHC, Triple Cylinder / 110 HP
DRIVETRAIN (DRIVE SYSTEM)	Selectable on-demand all-wheel drive, AWD/2WD/Turf/Ultra Turf Drive modes: Comfort, Standard, Sport, Tow/Haul
FRONT/REAR SUSPENSION	Dual A-Arm 12" (30.5 cm) Travel / Dual Arched A-Arm IRS 12" (30.5 cm) Travel
FRONT TYRES & REAR TYRES	30 x 10-15; Kenda® Cross Trail 30 x 11-15; Kenda® Cross Trail
OVERALL VEHICLE SIZE (L X W X H)	348 x 165 x 198 cm
GROUND CLEARANCE	38.1 cm
SEATING CAPACITY	3 / 6
BOX CAPACITY	680 KG
TOW CAPACITY	1,588 KG
OTHER STANDARD FEATURES	7" Display Powered by RIDE COMMAND, JBL® Trail Pro 2000 Audio, Premium Enclosed Cab, Doors with Power Windows, Tip-Out Glass Windshield with Wiper, Rear Glass Panel, Dome Light, Door Puddle Lighting, Interior Accent Lighting, Rear View Mirror, Heat, AC, Defrost, Contoured Heated Front Seats, Center Armrest, Telescoping Steering Wheel, Polaris Pulse Electrical System (6 position), 140 Amp Charging System, Front Bumper with D-Rings, Top Bar and Integrated LED Auxiliary Lights, DC Outlet, USB Charge Port, Trickle Charger, 12V Cargo Box Port, NorthStar Badge, Pro Series 2,721 KG Synthetic Rope Winch with Autostop and Rapid Rope Recovery plus Wireless Remote



GENERAL XP 1000

SPORT

ENGINE TYPE / HP	998cc, 4-Stroke DOHC, Twin Cylinder / 100HP
DRIVETRAIN (DRIVE SYSTEM)	True On-Demand AWD/2WD/ VersaTrac Turf Mode
FRONT/REAR SUSPENSION	Walker Evans Velocity Series Shocks High Clearance A-Arms 35.6 cm of Travel
FRONT TYRES & REAR TYRES	30 x 10-15; Pro Armor Crawler XGF 30 x 10-15; Pro Armor Crawler XG
OVERALL VEHICLE SIZE (L X W X H)	300 x 162.5 x 190.5 cm
GROUND CLEARANCE	34.3 cm
SEATING CAPACITY	2
BOX CAPACITY	272 KG
TOW CAPACITY	680 KG
OTHER STANDARD FEATURES	Poly Sport Roof, Low-Profile Sport Bumper, 2,041 KG Winch, Dumping Cargo Box, Premium Half Doors, LED Headlight with Accent and LED Taillights, Dual-Sweep Analog Gauge with 4" LCD Rider Information Center



RZR TRAIL S 1000

ULTIMATE

ENGINE TYPE / HP	998cc, 4-Stroke DOHC, Twin Cylinder / 100HP
DRIVETRAIN (DRIVE SYSTEM)	High Performance True On-Demand AWD/2WD/ VersaTrac Turf Mode
FRONT/REAR SUSPENSION	2" Walker Evans Racing Needle Shocks Standard Clearance A-Arms 12.25" (31.1 cm) / 13.2" (33.5 cm) Wheel Travel
FRONT TYRES & REAR TYRES	27 x 9-12; A/T 27 x 11-12; A/T
OVERALL VEHICLE SIZE (L X W X H)	282 x 152.4 x 176 cm
GROUND CLEARANCE	31.8 cm
SEATING CAPACITY	2
BOX CAPACITY	136 KG
TOW CAPACITY	680 KG
OTHER STANDARD FEATURES	RIDE COMMAND Off-Road Mapping Integrated into a 7" Display, Rockford Fosgate® Stage 2 Premium Audio, Poly Sport Roof, RZR Fang Accent Lighting



RZR XP 1000

SPORT

ENGINE TYPE / HP	ProStar 1000 4-stroke DOHC twin cylinder
DRIVETRAIN (DRIVE SYSTEM)	High-performance true on-demand AWD/2WD
FRONT/REAR SUSPENSION	Dual A-arm with stabilizer bar and 20" (50.8 cm) usable travel*, 16" (40.6 cm) of wheel travel Trailing arm with stabilizer bar and 20" (50.8 cm) usable travel*, 18" (45.7 cm) of wheel travel
FRONT TYRES & REAR TYRES	29 x 9-14 29 x 11-14
OVERALL VEHICLE SIZE (L X W X H)	303.5 x 162.6 x 180.6 cm
GROUND CLEARANCE	35.6 cm
SEATING CAPACITY	2
BOX CAPACITY	136.1 KG
TOW CAPACITY	N/A
OTHER STANDARD FEATURES	Center mounted information center w/ 4" color display + rotary speedometer + tachometers, programmable speed limiting, programmable service intervals, speedometer, tachometer, odometer, tripmeter, clock, hour meter, gear indicator, fuel gauge, coolant temperature, voltmeter, service indicator and codes, seat belt reminder light, DC outlet

**RZR PRO XP
ULTIMATE**

ENGINE TYPE / HP	925cc, 4-Stroke DOHC, Twin Cylinder, Turbo / 181 HP
DRIVETRAIN (DRIVE SYSTEM)	Isolated Xtreme Performance, True On-Demand AWD/2WD
FRONT/REAR SUSPENSION	FOX® 2.5 Podium Shocks DYNAMIX Semi-Active Suspension High-Clearance Dual A-Arms 20" (50.8 cm) / 22" (55.9 cm) Usable Travel*
FRONT TYRES & REAR TYRES	30 x 10-14 30 x 10-14
OVERALL VEHICLE SIZE (L X W X H)	320 x 162.6 x 182.1 cm
GROUND CLEARANCE	36.8 cm
SEATING CAPACITY	2
BOX CAPACITY	136 KG
TOW CAPACITY	N/A
OTHER STANDARD FEATURES	Sport Features Plus: Animated RZR Fang Accent Lighting, Rockford Fosgate® Stage 4 Audio, Sport Poly Roof, DYNAMIX Semi-Active Suspension, Telescoping Steering Wheel and Button Controls, High Clearance Radius Rods, Front Bull Bumper, 4-Pt. Harness

**RZR PRO R / RZR PRO R 4
ULTIMATE**

ENGINE TYPE / HP	1897cc, 4-Stroke DOHC, Inline Four Cylinder / 225 HP
DRIVETRAIN (DRIVE SYSTEM)	Pro Performance True 2WD/4WD/4WD Lock
FRONT/REAR SUSPENSION	FOX® 3.0 Live Valve X2 Shocks DYNAMIX DV Semi-Active Suspension Lightweight Boxed Dual A-Arms 27.0" (68.6 cm) / 29" (73.7 cm) Usable Travel*
FRONT TYRES & REAR TYRES	32 x 10-15; Pro Armor Trekker 32 x 10-15; Pro Armor Trekker
OVERALL VEHICLE SIZE (L X W X H)	347 x 188 x 185 cm 420 x 188 x 194 cm
GROUND CLEARANCE	40.6 cm
SEATING CAPACITY	2 / 4
BOX CAPACITY	136 KG
TOW CAPACITY	N/A
OTHER STANDARD FEATURES	Animated RZR Fang Accent Lighting, Rockford Fosgate® Stage 4 Audio with 1500W Digital Amplifier, 10.4" Touchscreen Display Powered by RIDE COMMAND, Rear Camera, Telescoping Steering Wheel & Button Controls, Color Matched 5-Lug Beadlock Wheels, Pro Climate Heat and Vent Seats, Aluminum Roof

YOUTH

RZR 200 EFI

ENGINE TYPE / HP	180cc, 4-Stroke, Single Cylinder EFI
DRIVETRAIN (DRIVE SYSTEM)	2WD, Chain
FRONT/REAR SUSPENSION	Dual A-Arm with 7" (17.8 cm) Travel / Independent Rear Suspension with 7" (17.8 cm) Travel
FRONT TYRES & REAR TYRES	24 x 8-12; CST® 24 x 10-12; CST®
OVERALL VEHICLE SIZE (L X W X H)	225.6 x 121.9 x 151.2 cm
GROUND CLEARANCE	25.4 cm
SEATING CAPACITY	2
FRONT/ REAR RACK CAPACITY	22.7 KG
TOW CAPACITY	N/A
OTHER STANDARD FEATURES	Safety Flag, Seat Belt, Safety Nets, Free Online Safety Training, Youth Ride Control (Pin Code Start, Adjustable Speed Limiter, Geofencing, Helmet Aware)

OUTLAW 110 EFI

ENGINE TYPE / HP	112cc, 4-stroke, single cylinder EFI
DRIVETRAIN (DRIVE SYSTEM)	2WD, Chain
FRONT/REAR SUSPENSION	Single A-arm with 12.7cm travel / Mono shock swingarm with 15.2 cm travel
FRONT TYRES & REAR TYRES	19 x 7-8 Duro 19 x 7-8 Duro
OVERALL VEHICLE SIZE (L X W X H)	155.6 x 93.3 x 97.8 cm
GROUND CLEARANCE	8.9 cm
SEATING CAPACITY	1
FRONT/ REAR RACK CAPACITY	N/A
TOW CAPACITY	N/A
OTHER STANDARD FEATURES	Safety flag, parent-adjustable speed limiter, free online safety training, safety tether



LIVE LIFE OFF ROAD.

Warning: Polaris Off-road vehicles can be hazardous to operate and are not designed for on-road use. Driver must have a valid driver's license to operate. All riders should always wear helmets, eye protection and footwear. Read, understand and follow your owner's manual. Ride within the limits of your own abilities and never engage in stunt or exhibition driving. Never ride under the influence of drugs or alcohol. All riders should take a safety training course.

Unless noted, all trademarks are the property of Polaris Industries Inc. 509® is a registered trademark of Teton Outfitters, LLC. Apple® and App Store® are registered trademarks of Apple Inc. Bluetooth® is a registered trademark of Bluetooth Sig, Inc. Caliber® is a trademark of Caliber, Inc. Cardo® is a registered trademark of Cardo Systems, Inc. Carhartt® is a registered trademark of Carhartt, Inc. CruzTools® is a registered trademark of CYCOACTIVE, INC. Facebook™ is a service trademark of META PLATFORMS, INC. Fidlock® is a registered trademark of Fidlock GmbH. FOX® is a registered trademark of Fox Factory Inc. Google Play™ is a service trademark of Google LLC. YouTube® is a registered trademark of Google LLC. Homelink® is a registered trademark of Gentex Corporation. Instagram™ is a service trademark of Instagram, LLC. JBL® is a registered trademark of HARMAN INTERNATIONAL INDUSTRIES, INCORPORATED. MORFLEX® is a registered trademark of FNA Group, Inc. NOCO Genius® is a registered trademark of The Noco Company. RHINO-RACK® and Zwifloc® are registered trademarks of Rhino Rack Australia Pty Limited. Rigid® is a trademark of JST Performance, LLC d/b/a Rigid Industries LLC. Seatsaver® is a registered trademark of Prince Lionheart, Inc. SMART BOARD® is a registered trademark of SMART TECHNOLOGIES ULC UNLIMITED LIABILITY CORPORATION CANADA. Tiger Drylac® is a registered trademark of Tiger Coatings GMBH & CO. KG. X™ is a service trademark of X CORP. Wallbox W™ is a service trademark of Wall Box Chargers, s.l. Prices, Fitment and Availability are subject to change at any moment. Copyright © 2026 Polaris Industries Inc. All rights reserved.



THE AMERICAN POWERSPORTS CO.



At Polaris, we believe being an American company isn't a sales pitch; it's a way of doing business. It's the place we call home. The place our riders call home.

It all began here in America—over 70 years ago—in a small factory in Roseau, Minnesota. There, our founders forged a company built on American values, grit and ingenuity. That factory is not so small anymore and still operates to this day—creating jobs and producing the best our industry has to offer. The best America has to offer.

Today, we continue to design, engineer and test our industry-leading vehicles with owners like you—right here on American dirt, sand, snow and soil.



POLARIS GLOBAL HEADQUARTERS
MEDINA, MINNESOTA, USA



POLARIS
Think Outside

MY26 POLARIS CATALOG
AUSTRALIA & NEW ZEALAND